

SEFAR® Tensocheck 100

Gebrauchsanweisung | Instructions for use |
Mode d'emploi | Instrucciones de uso | Istruzioni per l'uso

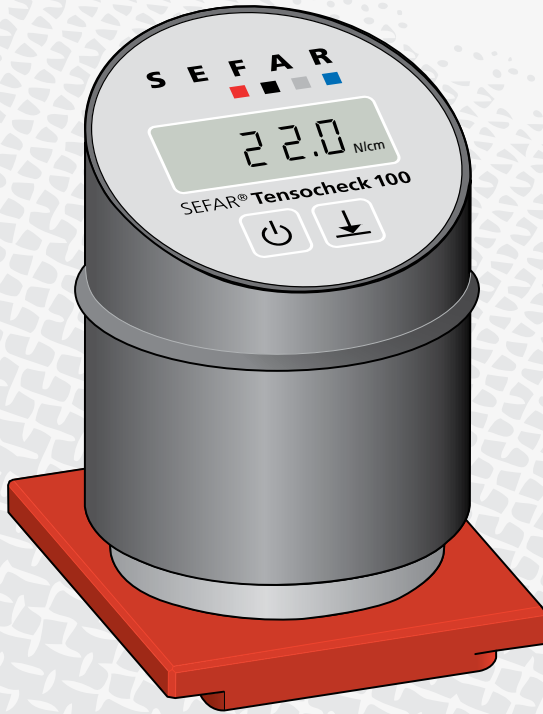

Technische Daten
 Technical Data
 Données techniques
 Datos técnicos
 Dati tecnici



9V Type 6LR61

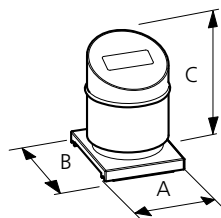

A 80 mm
 B 95 mm
 C 115 mm

1010 g

	<i>Arbeitsklima</i> Working environment Environnement de travail Entorno de trabajo Ambiente di lavoro	<i>Transport / Lagerung</i> Transportation / Storage Transport / Stockage Transporte / Almacenaje Trasporto / Conservazione
Temperatur / Luftfeuchtigkeit Temperature / Humidity Température / Humidité de l'air Temperatura / Humidità del aire Temperatura / Umidità dell'aria	15 – 35°C 40% – 60%	-10 – 60°C max. 85%
Auflösung / Resolution / Résolution / Resolución / Risoluzione	<30 N/cm >30 N/cm	= 0.2 N/cm = 0.5 N/cm
Messbereich / Toleranz (N/cm) Measuring range / Tolerance (N/cm) Plage de mesure / Tolérance (N/cm) Campo de medida / Tolerancia (N/cm) Campo di misura / Tolleranza (N/cm)	10 – 19.8 N/cm 20 – 29.8 N/cm 30 – 39.5 N/cm 40 – 50.0 N/cm	= +/- 0.4 N/cm = +/- 0.6 N/cm = +/- 1.0 N/cm = +/- 1.5 N/cm
Messbereich / Toleranz (mm) Measuring range / Tolerance (mm) Plage de mesure / Tolérance (mm) Campo de medida / Tolerancia (mm) Gamma di misura / Tolleranza (mm)	2.45 – 0.88(mm) 0.87 – 0.61(mm) 0.60 – 0.52(mm)	= +/- 0.05(mm) = +/- 0.04(mm) = +/- 0.03(mm)
Linearität / Wiederholpräzision Linearity / Repeatable precision Linéarité / Fidélité de reproduction Linearidad / Precisión de repetición Linearità / Precisione di ripetibilità	+/- 0.02mm / +/- 0.02mm	
<p>Extreme magn. und elektromagnetische Einflüsse können Störungen des Anzeigewertes verursachen. Extreme magnetic and electromagnetic influences may cause deviations in the values displayed. Des influences extrêmes magnétiques ou électromagnétiques peuvent perturber les valeurs affichées. Influencias extremas magnéticas o electromagnéticas pueden perturbar los valores indicados. Influenze magnetiche o elettromagnetiche estreme possono generare deviazioni dei valori indicati.</p>		
<p>Die tech. Daten für N/cm und (mm) sind nach DIN 16611, Anhang B, erhoben. Technical data for N/cm and (mm) are in accordance with DIN 16611, appendix B. Les données techniques pour N/cm et (mm) sont conformes à DIN 16611, annexe B. Los datos técnicos para N/cm y (mm) son conformes a DIN 16611, anexo B. I dati tecnici relativi a N/cm e (mm) sono conformi alla norma DIN 16611, allegato B</p>		



Optional

Kalibrations Kontrollplatte: Serielle Schnittstelle (Anbindung an das Steuergerät SEFAR® 51)
 Calibration control plate: Serial interface (link-up to the controll unit SEFAR® 51)
 Plaque de commande d'étalonnage: Connexion sérielle (connexion à l'appareil de commande SEFAR® 51)
 Placa de control de calibrado: Puerto Serial (conexión a la unidad de control SEFAR® 51)
 Piastra di controllo calibrazione: Connessione seriale (collegamento all'unità di controllo SEFAR® 51)



ON / OFF / Software Version

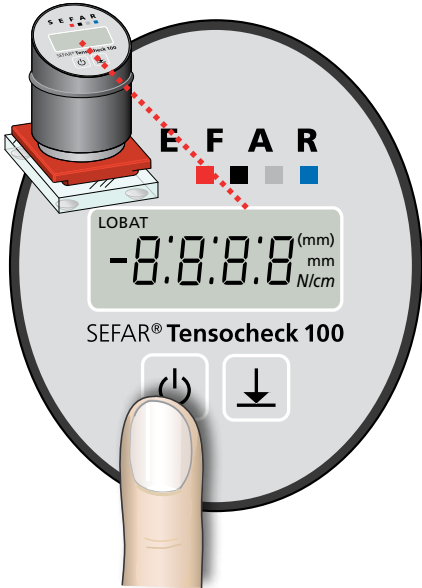

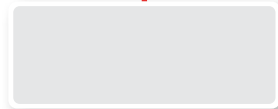

Software
Version



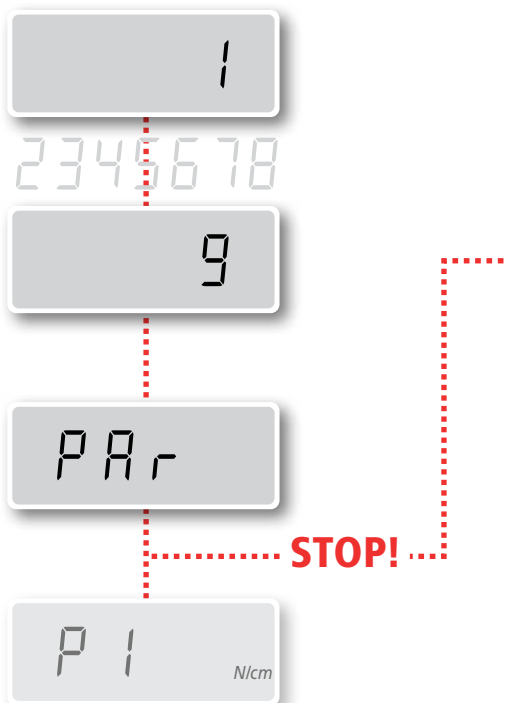
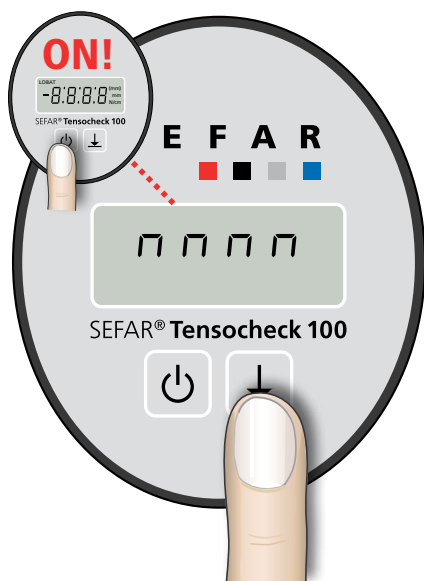

Masseinheit-, Timeout on/off wählen
 Select measured unit, Timeout on/off
 Choisir unité de mesure, Interruption on/off
 Elegir unidad de medida, interrupción on/off
 Scelta dell'unità di misura e modalità, Timeout on/off



Drücken Sie die Taste  ca. 9 Sekunden. Das Messgerät zählt nun von 1 bis 9. Sobald auf dem Display **«PAR»** erscheint, die Taste loslassen.

Pulsar la tecla  durante 9 segundos. El aparato de medida cuenta de 1 a 9. En cuanto aparezca **«PAR»** sobre el display, suelte la tecla.

Push button  for approximately 9 seconds. The device starts to counts from 1 to 9. When **«PAR»** is displayed release button.

Premere il pulsante  per circa 9 secondi. Il dispositivo inizia il conteggio da 1 a 9. Quando sul display appare **«PAR»** rilasciare il pulsante.

Appuyez la touche  durant env. 9 sec. L'appareil de mesure compte de 1 à 9. Dès que figure **«PAR»** sur le display, relâchez la touche.



(mm) In Asien benutzte Masseinheit
 Measurement unit used in Asia
 Unité de mesure utilisée en Asie
 Unidad de medida utilizada en Asia
 Unità di misura utilizzata in Asia

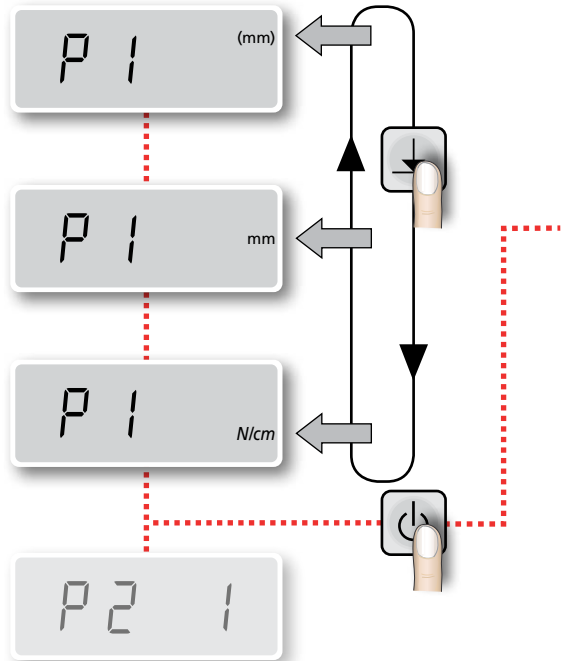

Nun können Sie durch betätigen der Taste die Masseinheit wählen. Bestätigen Sie die Eingabe mit der Taste . Dadurch gelangen Sie automatisch in den Timeout-Modus.

Select the preferred measuring units by pressing button . Confirm entry by pushing button . The screen will automatically advance to the time out screen.

Maintenant, vous pouvez choisir l'unité de mesure en activant la touche . Confirmez la donnée en appuyant la touche . Ainsi, vous êtes automatiquement en mode «temps mort».

Ahora, puede usted elegir la unidad de medida activando la tecla . Confirme la entrada pulsando la tecla . De esta manera, está automáticamente en modo «tiempo muerto».

Ora potete scegliere l'unità di misura preferita premendo il pulsante . Date conferma premendo il pulsante . In questo modo siete automaticamente in modalità Timeout

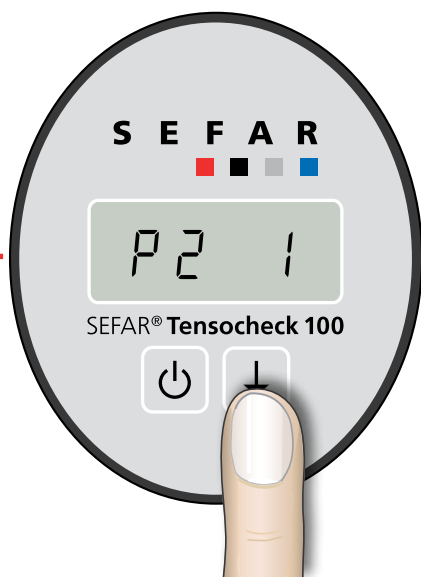





«Timeout»
ein / on / marche / en marcha

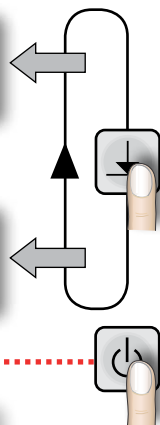





«Timeout»
aus / off / arrêt / apagado





Mit der Taste  können Sie nun die **«Timeout»** Funktion (Abschaltautomatik, 3 Minuten) ein- / ausschalten. Mit der Taste  schliessen sie die Eingabe ab und kehren in den Messmodus zurück.

By pressing button  you switch on/off the **«Timeout»** function (automatic switchoff after 3 minutes). With button  you select the entry and return to the measuring mode.

Avec la touche  vous pouvez activer ou désactiver la fonction **«Timeout»** (déconnexion automatique après 3 minutes). Avec la touche  vous confirmez l'entrée de donnée et revenez au mode de mesure.

Con la tecla  puede usted activar o desactivar **«Timeout»** (desconecta automáticamente después de 3 minutos). Con la tecla  termina la entrada de datos y vuelve al modo de medida.

Con il pulsante  potete attivare o disattivare **«Timeout»** (spegnimento automatico dopo 3 minuti). Con il pulsante  confermate l'ingresso dei dati e ritornate alla modalità di misura.

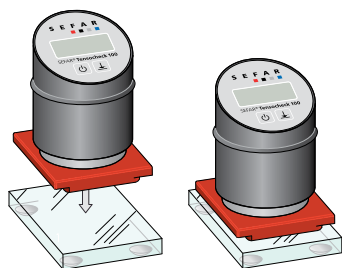

Nullstellung
Zeroing
Position zéro
Posición cero
Azzeramento

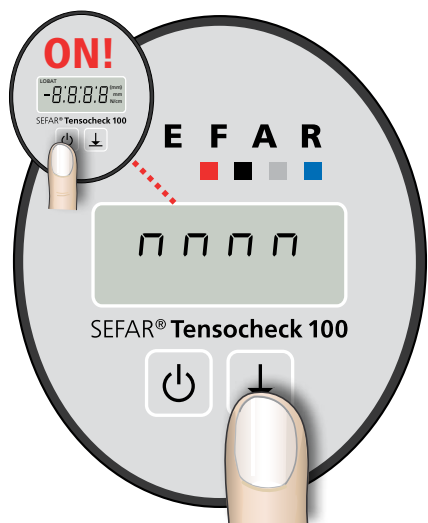

Um die Abweichung gegenüber dem Nullpunkt aufzuzeigen drücken Sie bitte Taste . Betätigen Sie die Taste innerhalb von 4 Sekunden nochmals, wird das Messgerät genullt. Nach einigen Sekunden wechselt das Messgerät automatisch in den Messmodus zurück.

To zero the SEFAR® Tensocheck 100, put the unit on the glass plate. Push button to show deviation to zero point. If you push the button within 4 seconds a second time, the measuring instrument will be zeroed. After a few seconds the device returns to the measuring mode.

Appuyez la touche afin de montrer la déviation par rapport au point zéro. Si vous activez à nouveau la touche dans les 4 sec., l'appareil de mesure se remet au point zéro. Après quelques secondes, l'appareil passe automatiquement en mode de mesure.

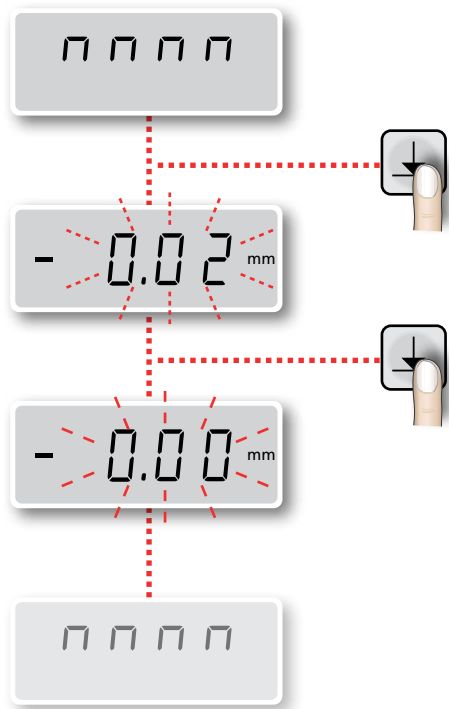

Pulsar la tecla para mostrar la divergencia del punto zero. Si usted aprieta por segunda vez la tecla dentro de 4 seg., el aparato vuelve al punto zero. Después de unos segundos, el aparato vuelve automáticamente al modo de medida.

Per azzerare SEFAR® Tensocheck 100, posizionate lo strumento sulla lastra di vetro. Premete il pulsante per evidenziare la deviazione dal punto zero. Premendo una seconda volta il pulsante per 4 secondi, lo strumento si azzerava. Dopo pochi secondi lo strumento ritorna automaticamente in modalità di misura.

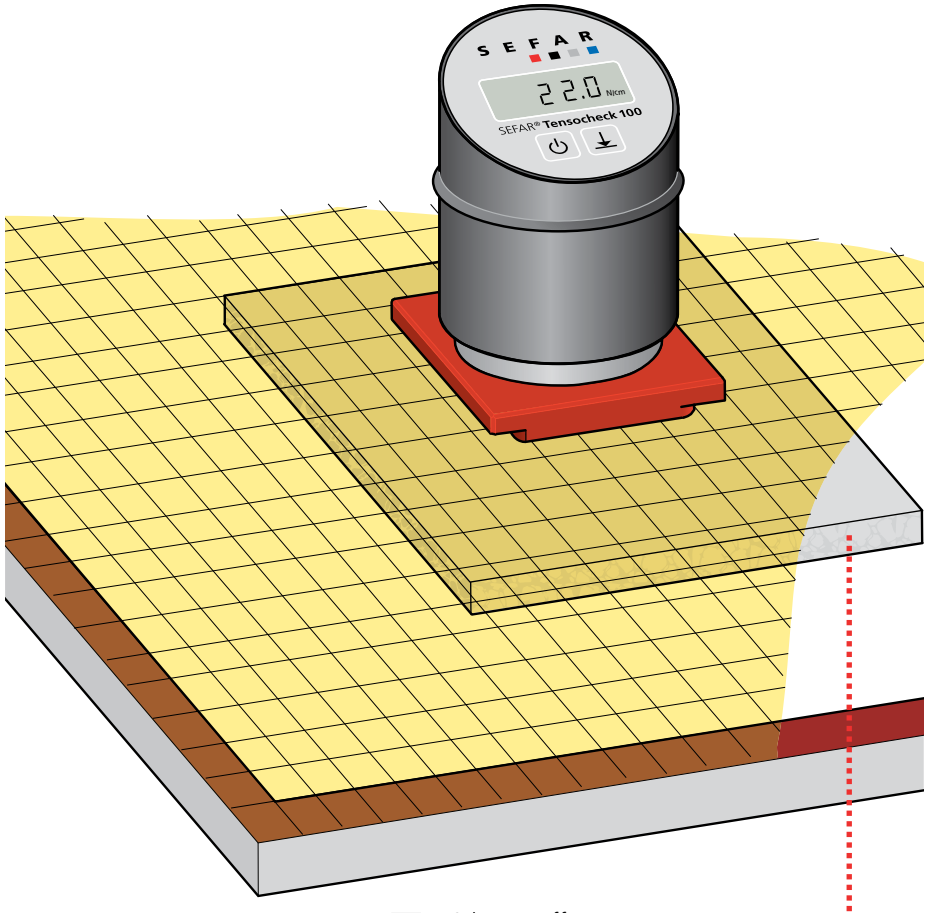

Schaumstoffmatte

Foam plastic mat (placed under the screen)

Tapis de caoutchouc mousse

Alfombra de espuma

Tappeto di schiuma (posizionato sotto il quadro)

1.

Wenn «LOBAT» blinkt, sofort neue Batterie einsetzen
If «LOBAT» flashes, replace the battery immediately
Si «LOBAT» clignote, mettez immédiatement une nouvelle pile
Al aparecer «LOBAT» en el display cambial las pilas
Quando lampeggia la scritta «LOBAT» sostituite immediatamente la batteria

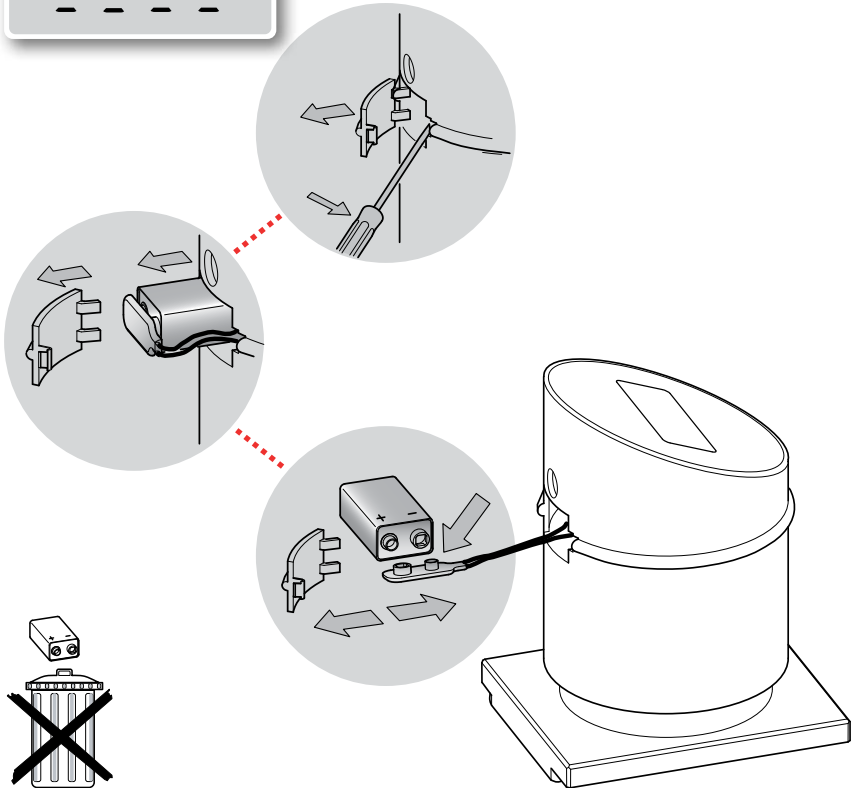
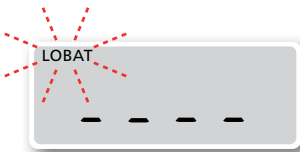

2.

Nullstellung (siehe Ablauf unter Kapitel III)
Zeroing (look at chapter III)
Position zéro (voir le chapitre III)
Posición cero (ver capítulo III)
Azzeramento (vedi capitolo III)



VI

Reinigung
Cleaning
Nettoyage
Limpieza
Pulizia

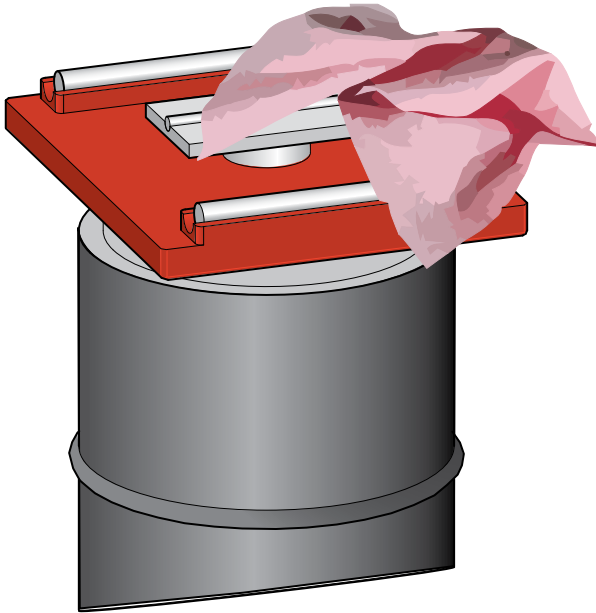

Auflagefläche des Gerätes ohne Lösungsmittel reinigen.
Do not use solvents to clean the support surface of the instrument.
Ne pas nettoyer la surface d'appui avec du solvant.
No limpiar la superficie de apoyo con disolventes.
Non utilizzate solventi per pulire la superficie d'appoggio dello strumento.

1.

Nullstellung (siehe Ablauf unter Kapitel III)
Zero the SEFAR® Tensoscheck 100 using the glass plate (look at chapter III)
Position zéro (voir le chapitre III)
Posición cero (ver capítulo III)
Azzeramento di SEFAR® Tensoscheck 100 con la piastra di vetro (vedi capitolo III)



2.

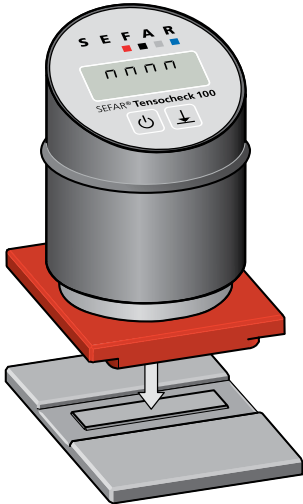

3.

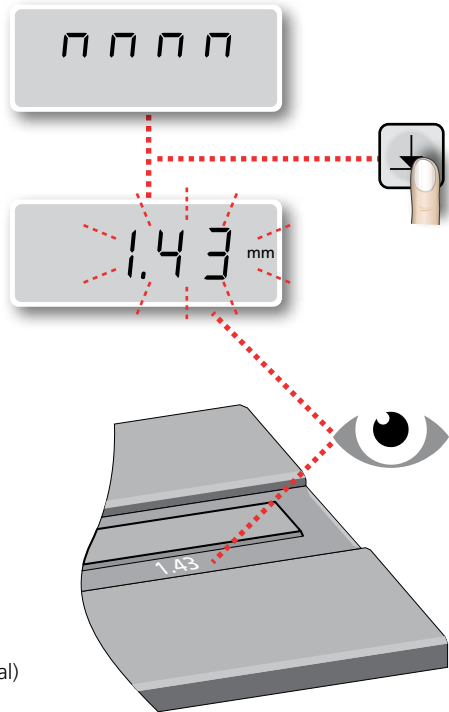

Kalibrations Kontrollplatte (optional)
Calibration control plate (optional)
Plaque de commande d'étalonnage (optional)
Placa de control de calibrado (opcional)
Piastra di controllo calibrazione (optional)

~~= +/- 0.02~~

~~> +/- 0.03~~

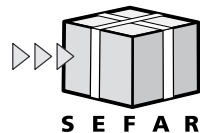

Sefar worldwide

Sefar is the leading manufacturer of precision fabrics from monofilaments for the screen printing and filtration market. Sefar products are used in a wide variety of industries, reaching from electronics, graphics, medical, automotive, food and pharmaceutical applications to aerospace, mining & refining and architecture. With its profound understanding of the applications Sefar helps its customers to achieve optimum results in their industrial processes. Subsidiaries and fabrications centers in 25 countries on 5 continents provide local technical service for the broad range of solutions offered by Sefar.

Headquarters

Sefar AG

Hinterbissastrasse 12
9410 Heiden – Switzerland
Phone +41 71 898 57 00
Fax +41 71 898 57 21
printing@sefar.com
www.sefar.com

Subsidiaries Americas

Sefar Inc.

Buffalo, NY – USA
Phone +1 800 995 0531
sales@sefar.us

Sefar SA de CV

Cuautitlan Izcalli – México City
Phone +52 55 5394 8689
info.mexico@sefar.com

Sefar Printing Solutions Ltda.

São Bernardo do Campo – Brazil
Phone +55 11 4390 6300
printing@sefar.com

Subsidiaries Asia

Sefar Singapore Pte. Ltd.

Singapore
Phone +65 6299 9092
info.sg@sefar.com

Sefar Trading (Shenzhen) Co. Ltd.

Shenzhen – China
Phone +86 755 2382 0322
printing@sefar.com

Sefar Filtration Solutions (Suzhou) Co., Ltd.

Suzhou – China
Phone +86 512 6283 6383
printing@sefar.com

Sefar (International) AG

Kwai Fong N.T. – Hongkong
Phone +852 2650 0581
printing@sefar.com

Sefar Filtration (India) Pte. Ltd.

Thane – India
Phone +91 2522 2940 34/35/36
printing@sefar.com

Sefar Co. Ltd.

Osaka – Japan
Phone +81 64 709 1070
info.jp@sefar.com

Subsidiaries Europe

Sefar Maissa S.A.U.

Cardedeu – Spain
Phone +34 93 844 47 10
printing@sefar.com



Our most current general sales conditions shall apply.
Please consult the most current local product data sheet prior to any use.

S E F A R

